

flexiguide

Product Specification

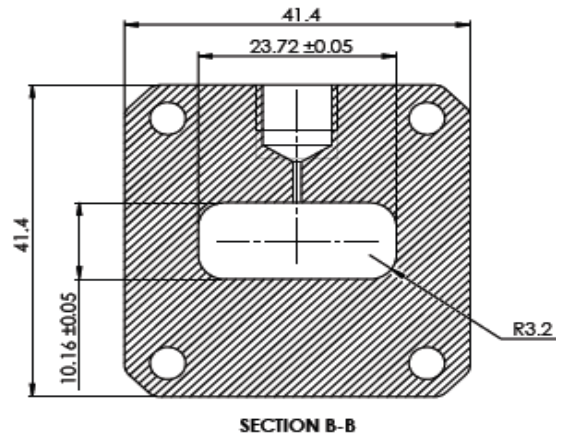
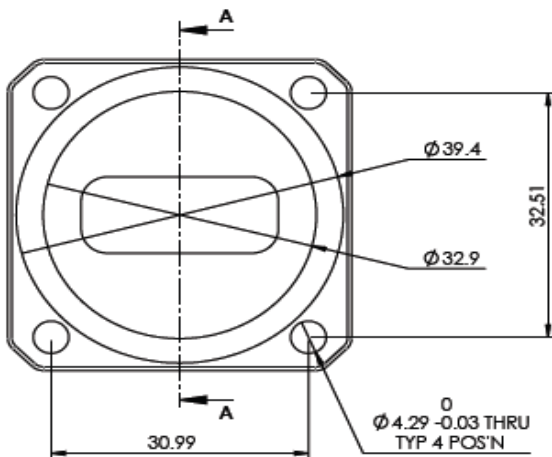

Part Number:

PI16K/Y-P-*-FK

* = see options below

Description

Product Type:
Waveguide Size:
Flange Type:
Equivalent to Flange:
Flange Material / Plating:
* Paint Finish:
Accessories:

Pressure Inlet
WG16 / WR90 / R100
16K (PBR100)
16Y (UG Cover + Groove)
Aluminium / Passivation
G = Gray (RAL 7012), B = Black, W = White
Screws, Nuts, Washers, O-Ring(s) / Gasket(s)

Mechanical Specifications

Thread Size:
Thickness:
Gasket Groove Depth:

1/8" BSP (Parallel) - not compatible with NPT/NPS
16 mm / 0.6 inches
2.03 mm / 0.08 inches

Electrical Specifications

Frequency Range: 8.20 - 12.4 GHz
Insertion Loss: 0.05 dB
Return Loss: 34.2 dB

Environmental Performance

Temperature Range: -70 to +150°C
ETSI Class: ETSI EN 300-019-2-4 Class 4.1
I.P. Rating: IP65 (Weatherproof)